

Highbay HP

lighting

nuBe



IP65

IK09

960°

+50°C
-25°C



High-performance high bay light with a luminous efficacy of 140 lm/W suitable for replacing older high bay luminaires in industrial environments.



PMMA diffuser available with 120° beam angle for a diffusing beam, also available are concentrating bells for 60° and 90° angles.

Applications

Industry, logistics warehouses, hangars

Characteristics

Power supply

93÷265 VAC - 50/60Hz 176÷250 VDC

Power supply - MTBF at 25°C 100,000h

Luminous flux retention at 25°C

>50,000h (L80B20)

Colour stability 3 SDCM

Mounting Suspended, ceiling, wall, floor

Housing Polyester powder-coated die-cast aluminium, RAL 7040

Optics Round PMMA Lens

Compliance EN60598-1, EN60598-2-1, EN 62471, 2014/53/EU, EN60598-2-22, DIN 18031-3

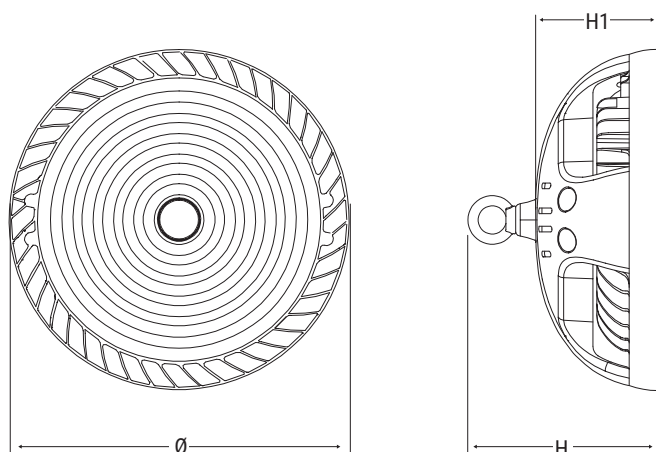

Version	Order code	Dimensions mm		
		H	H1	Ø
SD	40224-40225	207	148	300
	40226-40227	229	165	360
ED	40204-40205	167	108	300
	40206-40207	189	125	360

240W VERSION

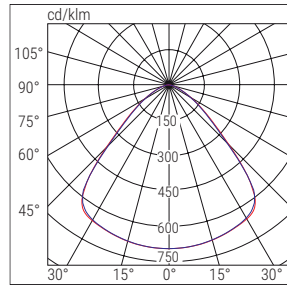

■ C0-C180 ■ C90-C270

	Order Code	Description	Power W	Colour temp. K	Chromatic yield	LED Flux lm (Tj=25°C)	Luminaire flux lm	Brightness efficiency lm/W	Weight Kg	Packaging Single/ Multi pack	Notes and compliance
SD	40224	HIGHBAY HP 100W 90° 4K SD	100	4000	≥80	16500	14000	140	3.9	1	90° Optics
	40225	HIGHBAY HP 150W 90° 4K SD	150	4000	≥80	25000	21000	140	4.5	1	90° Optics
	40226	HIGHBAY HP 200W 90° 4K SD	200	4000	≥80	33000	28000	140	7.0	1	90° Optics
	40227	HIGHBAY HP 240W 90° 4K SD	240	4000	≥80	40000	34000	142	7.5	1	90° Optics
ED	40204	HIGHBAY HP 100W 90°0-10V 4K ED	100	4000	≥80	16500	14000	140	4.2	1	90° Optics
	40205	HIGHBAY HP 150W 90°0-10V 4K ED	150	4000	≥80	25000	21000	140	4.8	1	90° Optics
	40206	HIGHBAY HP 200W 90°0-10V 4K ED	200	4000	≥80	33000	28000	140	7.4	1	90° Optics
	40207	HIGHBAY HP 240W 90°0-10V 4K ED	240	4000	≥80	40000	34000	142	7.9	1	90° Optics

(*) Function that can be activated by integrating the optional external light sensor Code 21100

ACCESSORIES - included



SD RADIO / 1 -10V INTERFACE





EYE-BOLT FOR SUSPENDED MOUNTING

ACCESSORIES - to be ordered separately



GLASS DIFFUSER HP 120°

Order Code **40900** (100/150W)
Order Code **40901** (200/240W)



BELL 70° HP

Order Code **40904** (100/150W)
Order Code **40905** (200/240W)



DIFFUSER HP 120° 100/150W

Order Code **40902** (100/150W)
Order Code **40903** (200/240W)



BELL 90° HP

Order Code **40906** (100/150W)
Order Code **40907** (200/240W)



SWIVEL BRACKET HP



Order Code **40908** (100/150W)
Order Code **40909** (200/240W)

BUILDING AUTOMATION - to be ordered separately



LOGICA SD LGFM CONTROL UNIT

Order Code **21102**



BUILDING AUTOMATION RADIO TRANSMITTER

Order Code **20104**

